

# V1524A, B & C Western White Flyer Electric Trap Parts

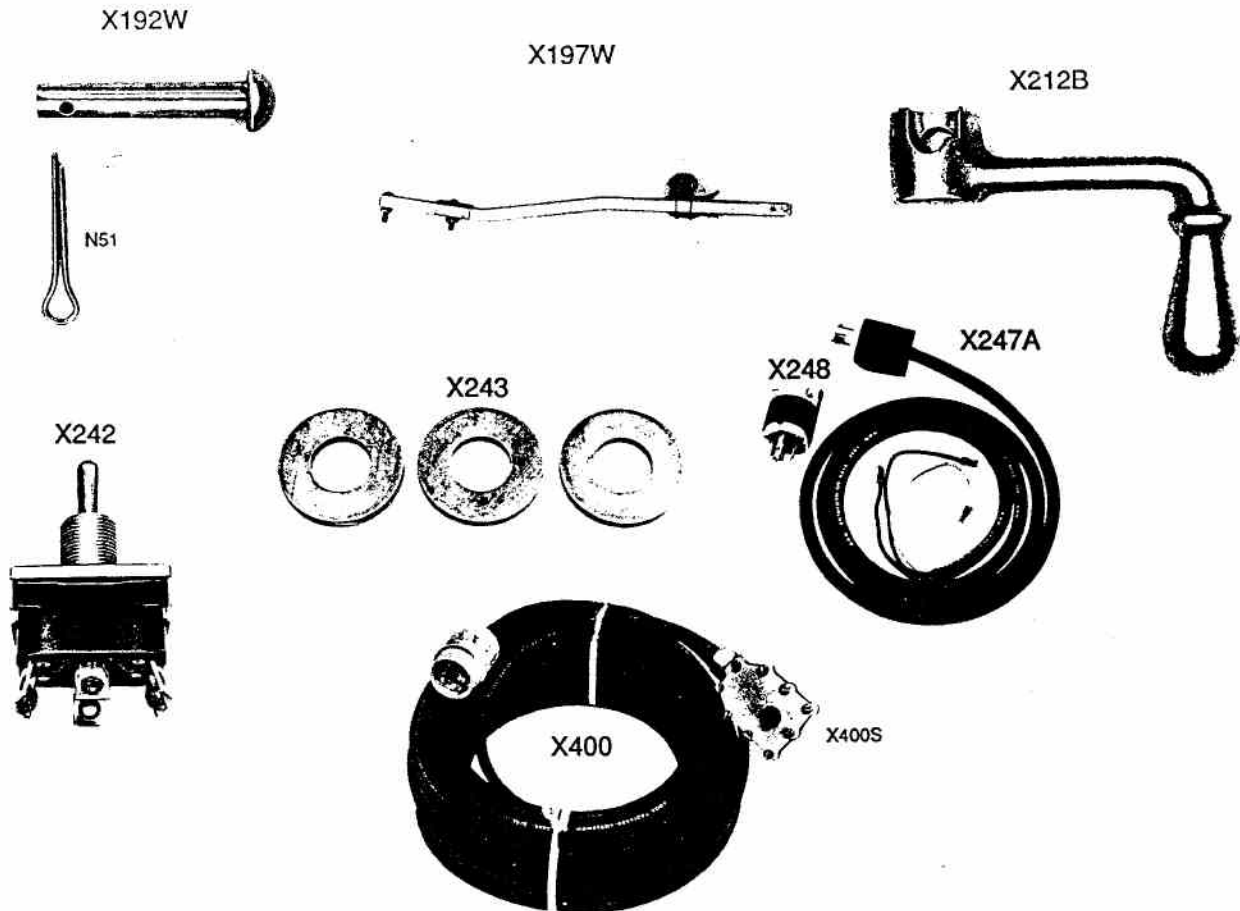

CAT.NO.	NAME
X192W	Stop Finger Pivot Assembly
X193	Target Stop Sliding Finger (not shown)
X194	Target Stop Locking Finger (not shown)
X195	Target Stop Locking Spring (not shown)
X196A	Bushing for X16BW, X3AW, X4BW (not shown)
X197W	Target Stop Complete Assembly of all stop components on X187AW bar
X212B	Mainspring Adjusting Speed Crank
X241	Magnetic Oil Plug (not shown)
X242	Master Switch (3 position)
X243	Planet Gear Spacer (set of 3) required only f using X68DW on V1524A, V1579A or V1581A trap without factory interruptor-install one beneath each X110W
X247A	Power Cord without Cap
X248	Power Cord Connector Cap (115V)
U346	Strain Relief Connector (not shown)
U390	Hitch Pin for X39AW (not shown)
X400	Trap Release Assembly
X400S	Trap Release Switch End Assembly
X450	Trap Guard (not shown)

TRAPS AFTER SERIAL NUMBER X8453 USE X247A, X248 & X249 PARTS.

V1579C

V1581C

Special Parts used in

V1579C Western Modified Clay Pigeon Trap

V1581C Western Modified International Trap

(See pages 20 thru 29 for all parts which are not illustrated or listed below or on the following page.)

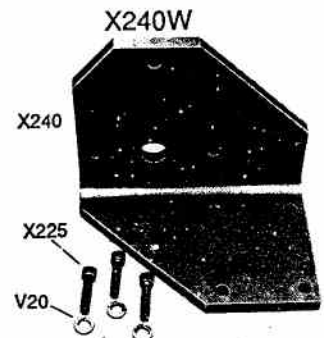
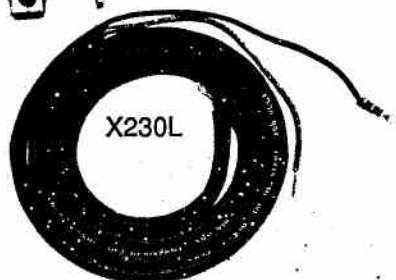
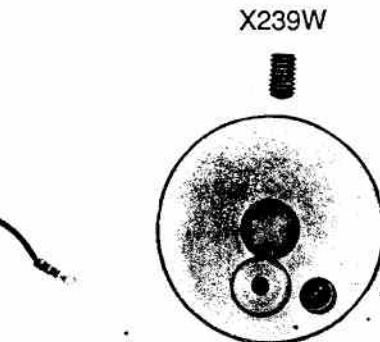
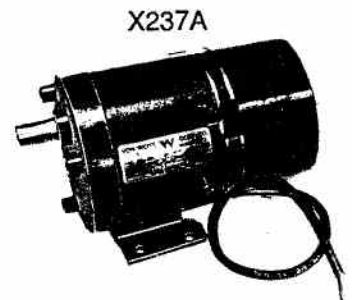
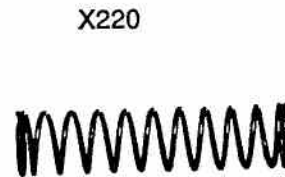
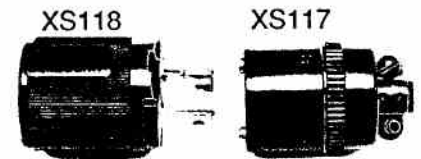
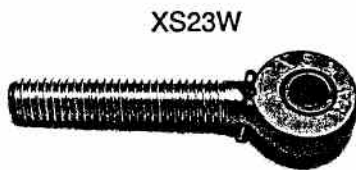
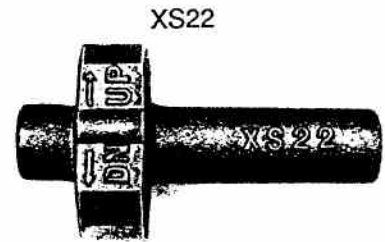
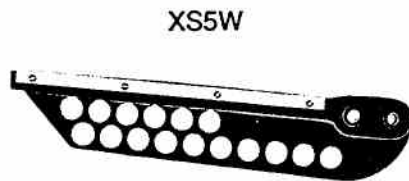

V1579C  
V1581C

Special Parts used in  
V1579C Western Modified Clay Pigeon Trap  
V1581C Western Modified International Trap

CAT.NO.	NAME
* XS3AW	Lower Frame Assby for VonWeise Elevation Motor
XS5W	Carrier Assembly for International Distance 110.00
XS22	Elevation Adjusting Nut
XS23W	Elevation Adjusting Screw, Lower (RH thread)
XS24	Elevation Adjusting Screw, Upper (LH thread)
X77W	Crank Disc Pivot Screw Assembly (not shown)
XS117	Connector Body for Cable X230L
XS118	Connector Cap for Elevation Motor Cord
XS127	Release Solenoid for 220V, 50 HZ (not shown)
X127A	Release Solenoid for 115V, 60 HZ (not shown)
XS128	Control Solenoid for 220V, 50 HZ (not shown)
X128B	Control Solenoid for 115V, 60 HZ (not shown)
X216W	Elevation Motor Disc Assembly (Bodine) (not shown)
X217W	Elevation Crank Disc Assembly
X219	Crank Disc Lock Plunger
X220	Disc Lock Plunger Spring
X221	Elevation Holding Spring
X223	Crank Stud Washer (not shown)
X225W	Motor Mounting Bolt (set of 4)
X230L	Elevation Motor Cable Long
X231W	Elevation Motor Switch
X237A	Elevation Changing Motor 115V, 60HZ (VonWeise)170.15
X238A	Elevation Changing Motor 220V, 50HZ (VonWeise) (not shown)
X239W	Elevation Motor Disc Assby (VonWeise)
X240W	Adapter Assby for Mounting VonWeise Elevation Changing Motors to XS3W Lower Frames (also order X239W)
X254	Replacement Intermediate Gear for X237A & X238A (not shown)
X450	Safety Cord (not shown)

\*THE REPLACEMENT OF THIS PART IN THE FIELD IS NOT RECOMMENDED BECAUSE OF COMPLICATED FITTING AND REWIRING. . .

# V400 Skeet Release X400 Trap Release and Adapters

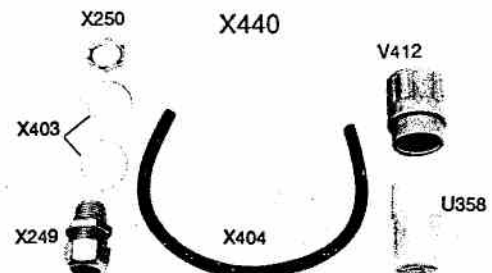
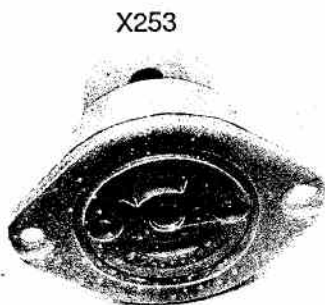
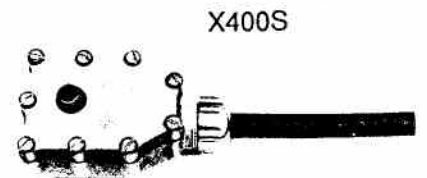
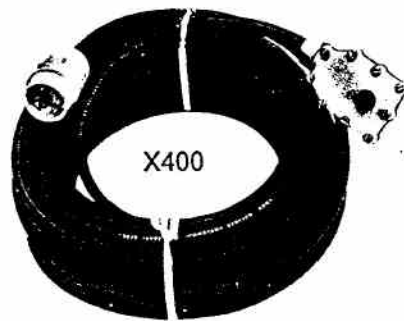
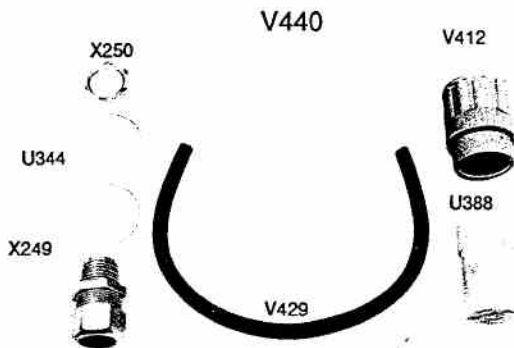
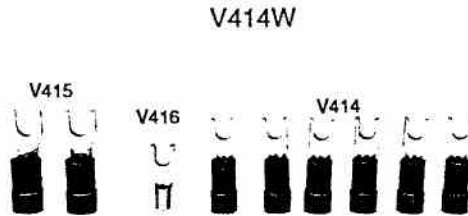
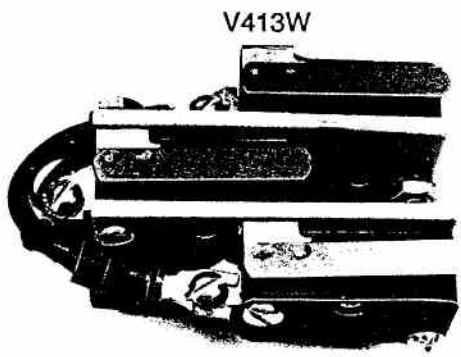
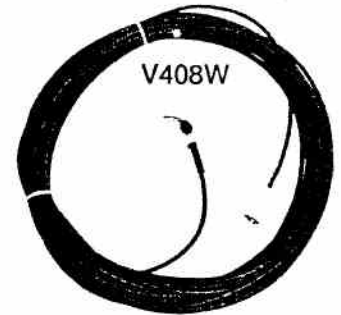
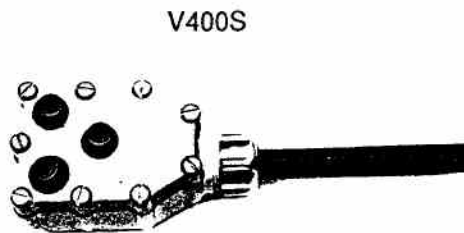
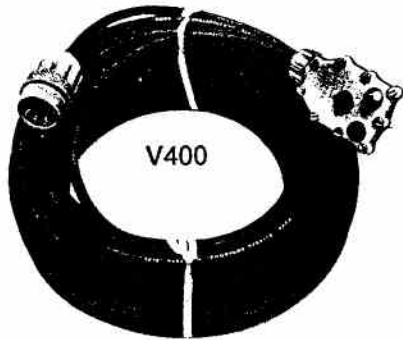

---

## V400 Skeet Release X400 Trap Release and Adapters

<b>CAT.NO.</b>	<b>NAME</b>
U358	Connector (not shown)
V400	Skeet Release Assembly
V400S	Skeet Release Switch End
V401	Housing (not shown)
V402	Cover (Skeet) (not shown)
V403A	Button (not shown)
V404	Separator (not shown)
V405	Diaphragm (not shown)
V406	Strain Relief (not shown)
V407	Washer (not shown)
V408W	Cord
V409	Gland (not shown)
V410	Cover Screw (not shown)
V411	Plug (not shown)
V412	Boot (not shown)
V413A	Switch (use with V430) (not shown)
V413W	Switch Assembly (3 switches)
V414W	Terminals (set of 9 for skeet release)
V415W	Terminals (set of 2 for trap release)
V417W	Switch Wire Assembly (not shown)
V419W	Switch Wire Assembly (not shown)
V422	Screw, 4-40 x 1 1/2 long (not shown)
V423	Screw, 4-40 x 3/4 long (not shown)
V424	Screw, 4-40 x 1/2 long (not shown)
V425	Nut, 4-40 (not shown)
V426	Lockwasher #4 (not shown)
V427	Pin (not shown)
V428	Button Seal (not shown)
V430	Actuator (use with part V413A) (not shown)
V440	Adapter (skeet parts required to install V400 release on older traps)
X253	Receptacle
X400	Trap Release Assembly
X400S	Trap Release Switch End Assembly
X401	Cover (not shown)
X402W	Release Cord Assembly
X440	Adapter Release Kit

# V1574A & B

## Western Self-Loading Electric Skeet Trap Parts

V1A



V2AW

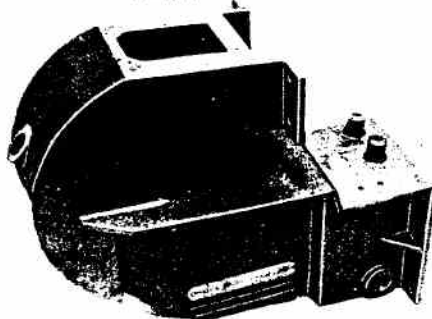

V3AW



V4W



V5A



V6

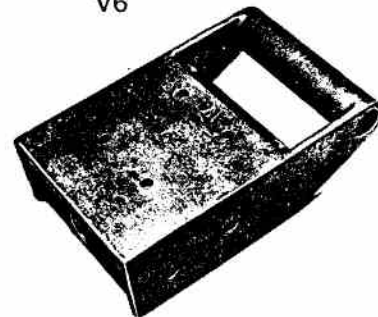

V7A

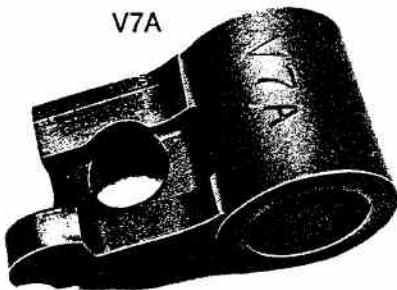

V8

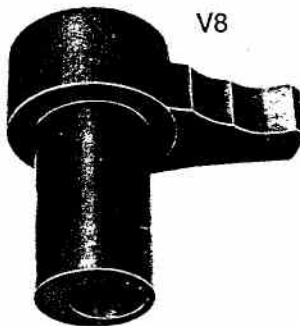

V9AW



CAT.NO.	NAME
V1A	Base
V2AW	Frame Assembly
V3AW	Gear Housing Assembly
V4W	Gear Housing Cover & Feed Cam Assembly
V5A	Mainspring Housing
V6	Solenoid Housing
V7A	Cocking Pawl
V8	Hold Back Pawl
V9AW	Control Cam Assembly

# V1574A & B

## Western Self-Loading Electric Skeet Trap Parts

V10W

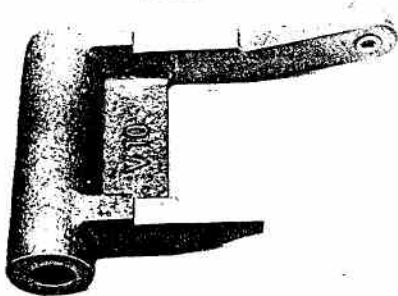

V13R



V13L

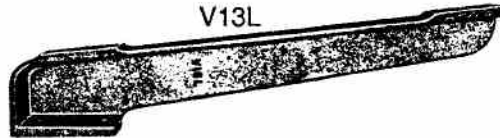

V14W

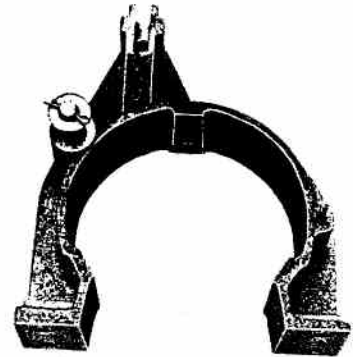

V15



V16

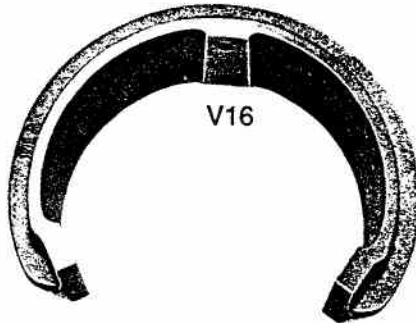

V17B

V17CW

V17CW

V18A

V19W

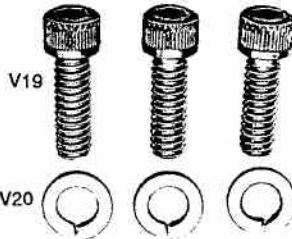

CAT.NO.	NAME
V10W	Sear Assembly
V11W	Trigger Arm Assembly (not shown)
V12	Trigger Dog (not shown)
V13R	Magazine Support RH
V13L	Magazine Support LH
V14W	Lower Magazine Support Bracket Assby
V15	Intermediate Magazine Bracket
V16	Upper Magazine Bracket
V17B	Rear Right Rail
V17C	Rear Left Rail (not shown)
V17CW	Rear Left Magazine Guide Rail (w/3 spacers)
V18A	Front Magazine Rail
V19W	Magazine Guide Rail Screw (set of 3)

# V1574A & B Western Self-Loading Electric Sket Trap Parts

V23W

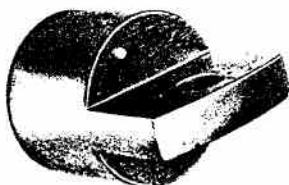

V28W



V24



V35AW

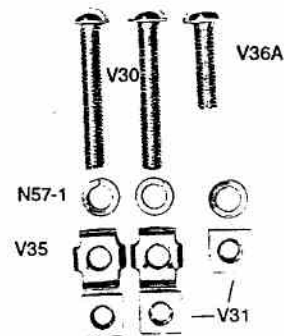

V28CW



V29W

V29AW

V20

V49



X36W



X39AW

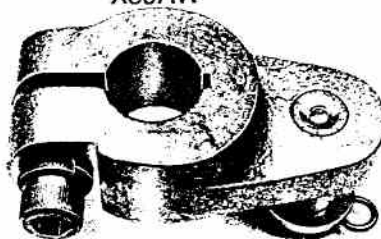

XU40W



X43

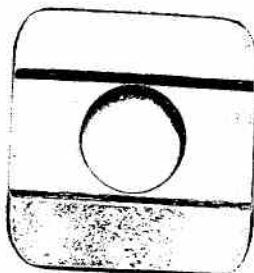

X42

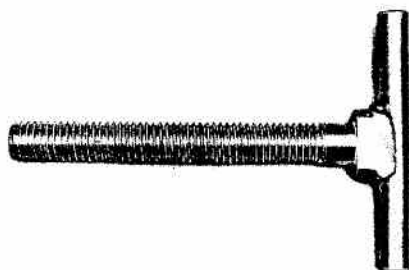

V46

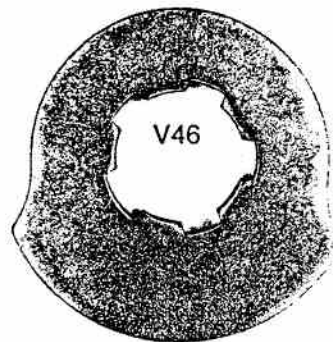

V45

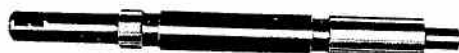

V47W

V47

V103A

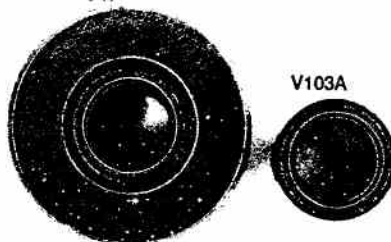

V50AW

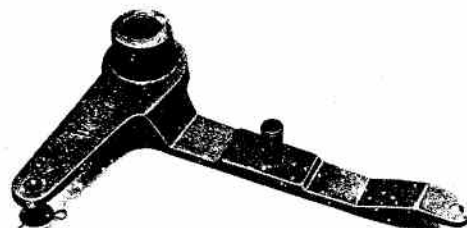

# V1574A & B

V51A

## Western Self-Loading Electric Skeet Trap Parts

V59W

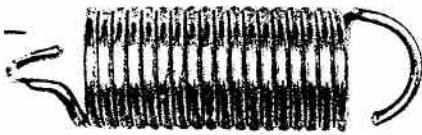

N52-1A

X162

V164



CAT.NO.	NAME
V23W	Magazine Stabilizer Assembly
V24	Magazine Stabilizer Spring
V27	Carrier Arm (not shown)
V27A	Carrier Arm (International) (not shown)
V28	Carrier Plate (not shown)
V28C	Carrier Plate (International) (not shown)
V28W	Carrier Assembly Complete
V28CW	Carrier Assembly Complete (Intl)
V29W	Carrier Plate Screws (set of 3)
V32W	Carrier Rail Assembly (10 1/2") (not shown)
V32AW	Carrier Rail Assembly (Intl) (11 1/2") (not shown)
V34	Carrier Rail Support (not shown)
V35AW	Two Rail Nut Anchors w/set of Carrier Rail bolts
V36AW	Trap Grounding Bolt (not shown)
X36W	Worm Shaft Gland Assembly
X37	Washer for Crank Stud and Escapement Stud (not shown)
X39AW	Mainspring Crank Assembly
+ XU40W	Mainspring Assembly
X42	Mainspring Adjusting Screw
X43	Mainspring Swivel
V45	Mainshaft
V46	Target Escapement Cam
V47W	Escapement Cam Roll Assembly
V49	Retaining Washer for Items V47W, V209C & V215A (not shown)
V50AW	Escapement Lever Assembly
V51A	Escapement Lever Spring
V52B	Escapement Cushion (not shown)
V54	Pivot (not shown)
V55	Escapement Lever Stud (not shown)
V56	Escapement Lever Spring (not shown)
V57A	Trigger
V58	Trigger Pull Rod (see pg. 38 for illst.)
X58	Trigger Arm Spring (see pg. 38 for illst.)
V59W	Trigger Mounting Bolt Assembly

+A USED XU40W MAINSPRING ASSEMBLY MAY BE RETURNED TO THE FACTORY FOR RECONDITIONING WITH NEW SPRING AND BUSHING. PRICE OF THE RECONDITIONED ASSEMBLY \$33.00, PLUS \$7.00 SERVICE CHARGE TO DEFRAY EXPENSE OF UNPACKING, TESTING AND REPACKING FOR SHIPMENT.

Note: V27A, V28C, V32AW (none shown) for domestic & International throwing distances are installed on V1574B traps beginning with Serial No. 6498. Parts are not interchangeable with V27, V28, and V32W. Conversion Kit V218 is available to provide older machines with International throwing distance capability. Kit is priced at \$170.00 contains 1 each V28CW, XU40W, and V209C:

# V1574A & B Western Self-Loading Electric Skeet Trap Parts

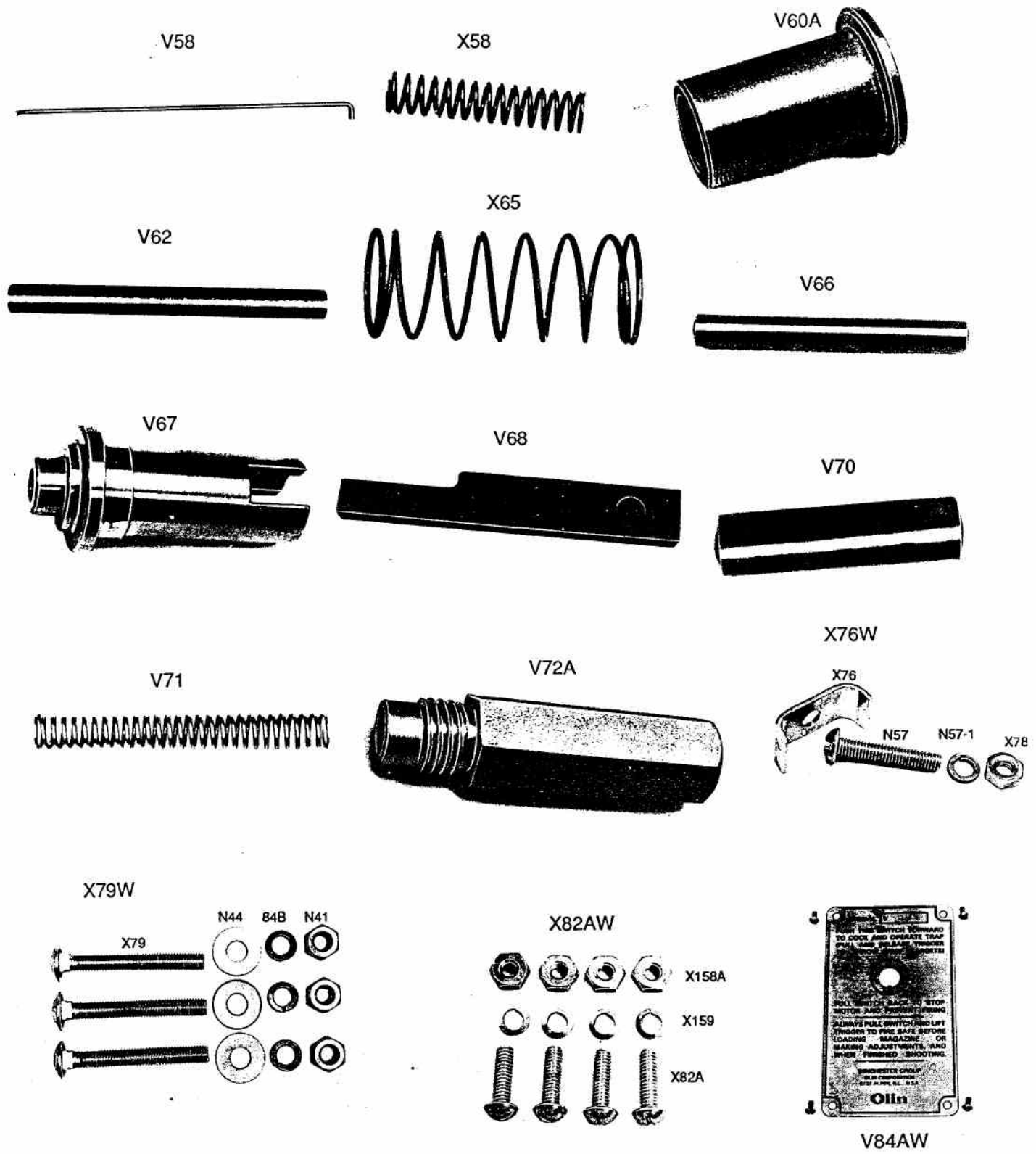

# V1574A & B

## Western Self-Loading Electric Skeet Trap Parts

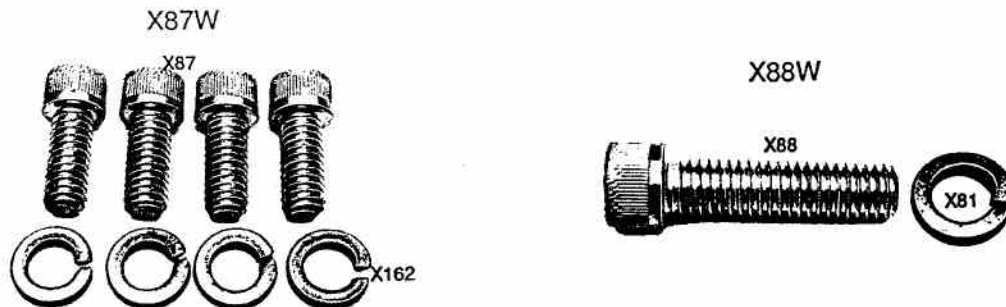

CAT.NO.	NAME
V60A	Trigger Bushing
V62	Shaft for Sear and Hold-Back Pawl
V63W	Pawl Holding Magnet Assembly (not shown)
X65	Cocking Pawl Spring
V66	Firing Pin
V67	Firing Pin Guide
V68	Firing Pin Bar
V70	Sear Plunger
V71	Sear Spring
V72A	Sear Plunger Bushing
X76W	Cable Anchor Clip Assembly
X79W	Base Bolts (set of 3)
X82AW	Solenoid Mounting Bolts (set of 4)
V84AW	Switch Indicator Plate Assembly
X87W	Screws for Gear Housing Cover or Worm Shaft Gland (also used to pull V62 shafts from housing) (set of 4)
X88W	Clamp Screw Assembly for Mainspring Crank
V91W	Magazine Support Screw (set of 2) (not shown)
V92W	Magazine Bracket Bolts (set of 2) (not shown)
V93W	Gear Housing Mounting Screws (set of 4) (not shown)
X94	Key for Mainspring Crank (not shown)
V96A	Bushing for V3AW (not shown)
V97	Bushing for V108AW (not shown)
V98A	Bushing for V4, U381 (not shown)
V99A	Bushing for V110W (not shown)
V100	Bushing for U190W, U4W, V4W & V194W (not shown)
V101	Bushing for V155AW (not shown)
V102	Bushing for U398W & V50AW (not shown)
V103A	Bushing for V47W (not shown)
V104B	Bushing for V192W, X3AW, XS3AW (not shown)
V105W	Main Shaft Oil Seal & Lower Bearing Assembly (not shown)
X106A	Worm Shaft Oil Seal (not shown)

# V1574A & B

## Western Self-Loading Electric Skeet Trap Parts

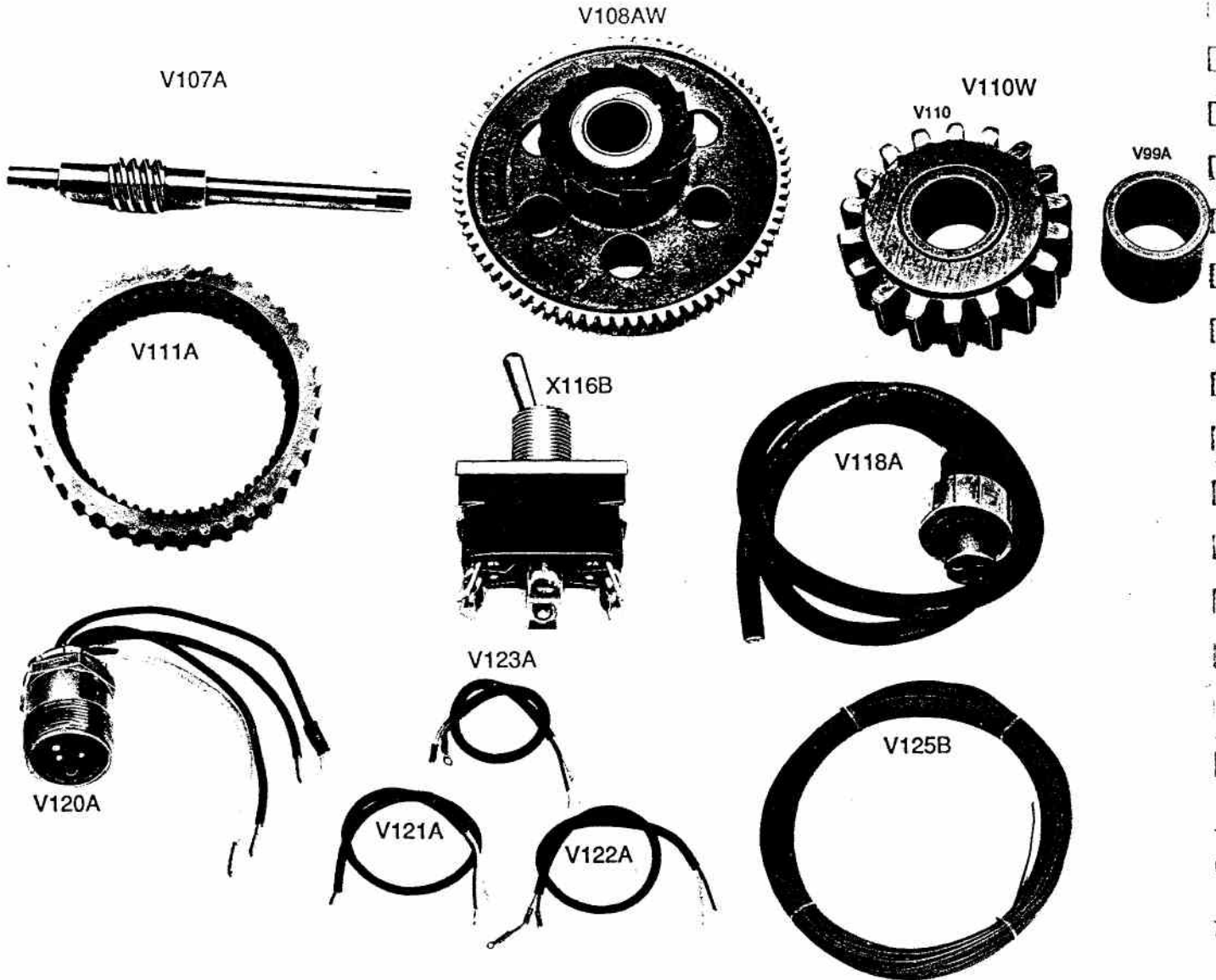

CAT.NO.	NAME
V107A	Worm
V108A	Worm Gear (not shown)
V108AW	Worm Gear Housing
V110W	Planet Gear Assembly
V111A	Ring Gear & Ratchet (International)
X116B	Master Switch
V118A	Power Cord Assembly
V120A	Power Receptacle Assembly
V121A	Solenoid Cable
V122A	Switch Cable
V123A	Motor Cable
V125B	Field Cable

# V1574A & B

## Western Self-Loading Electric Skeet Trap Parts

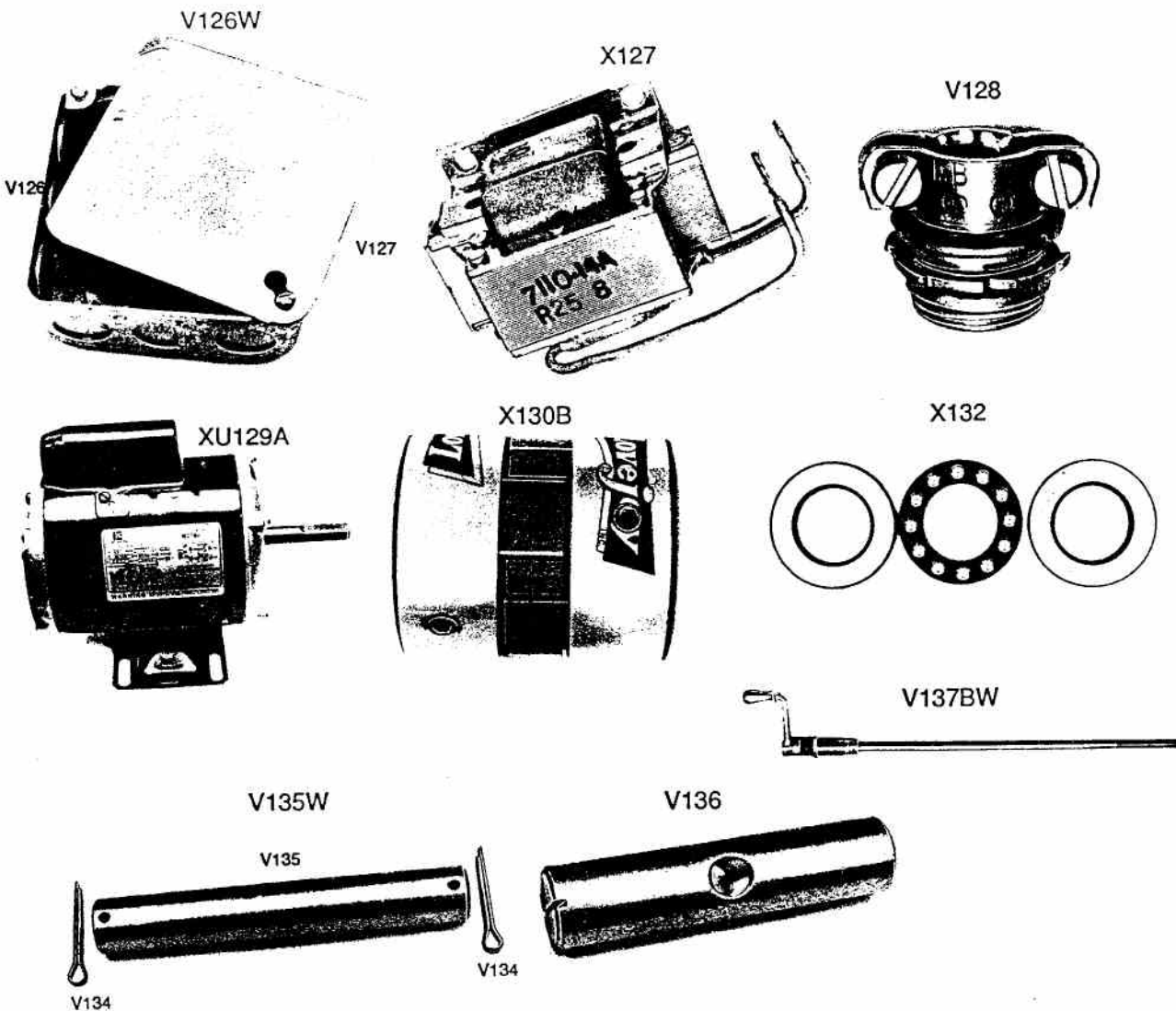

CAT.NO.	NAME
V126W	Outlet Box Assembly
X127	Release Solenoid (115V)
V128	Squeeze Type Two Screw Connectors
XU129A	Cocking Motor (115/230V, 60/50 HZ)
X130B	Motor Coupling
X132	Worm Thrust Bearing
X133	Oil Filler & Level Gage Plug, ea. (not shown)
V134W	Assorted Cotter Pins (not shown)
V135W	Elevation Pivot Assembly
V136	Elevation Screw Swivel
V137BW	Elevation Adjusting Screw Assembly
V141	Tool for Guiding Main Shaft thru Oil Seal (not shown)

# V1574A & B

## Western Self-Loading Electric Skeet Trap Parts

V151W



V155AW



V157W

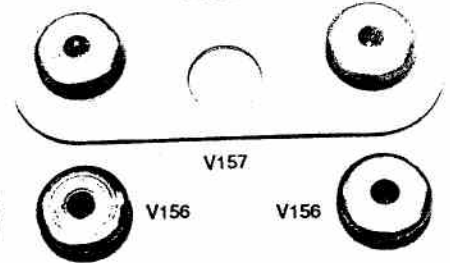

V160W

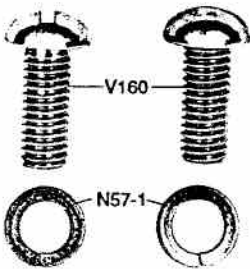

V161W

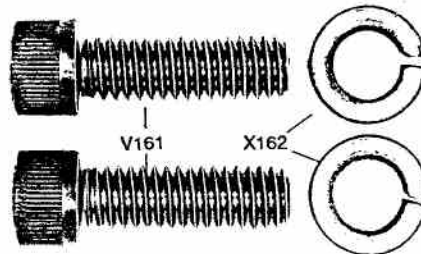

V163W

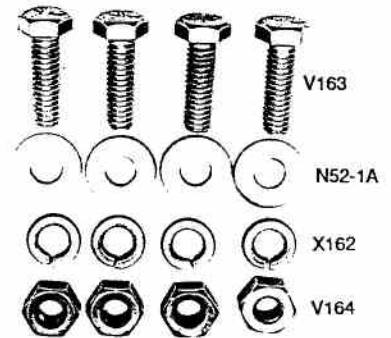

V173W

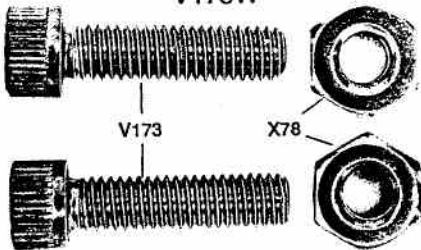

V190W



V191W

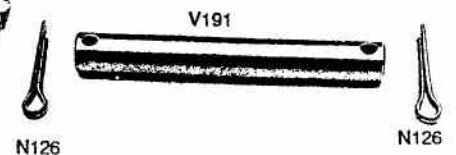

V192W

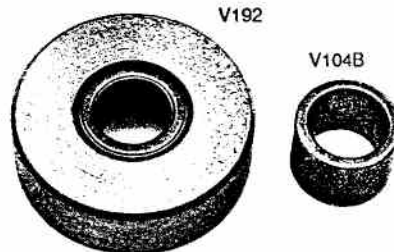

CAT.NO.	NAME
V151W	Escapement Cushion Assembly
V155AW	Escapement Carrier Base Assembly
V157W	Escapement Cushion Cover Assembly
V160W	Escapement Cushion Cover Screws (set of 2)
V161W	Solenoid Housing Screws (set of 2)
V163W	Motor Mounting Bolts (set of 4)
V173W	Motor Support Screws (set of 2)
V190W	Target Feed Arm Assembly
V191W	Target Feed Arm Pivot Assembly
V192W	Target Feed Cam Roll Assembly

# V1574A & B

## Western Self-Loading Electric Skeet Trap Parts

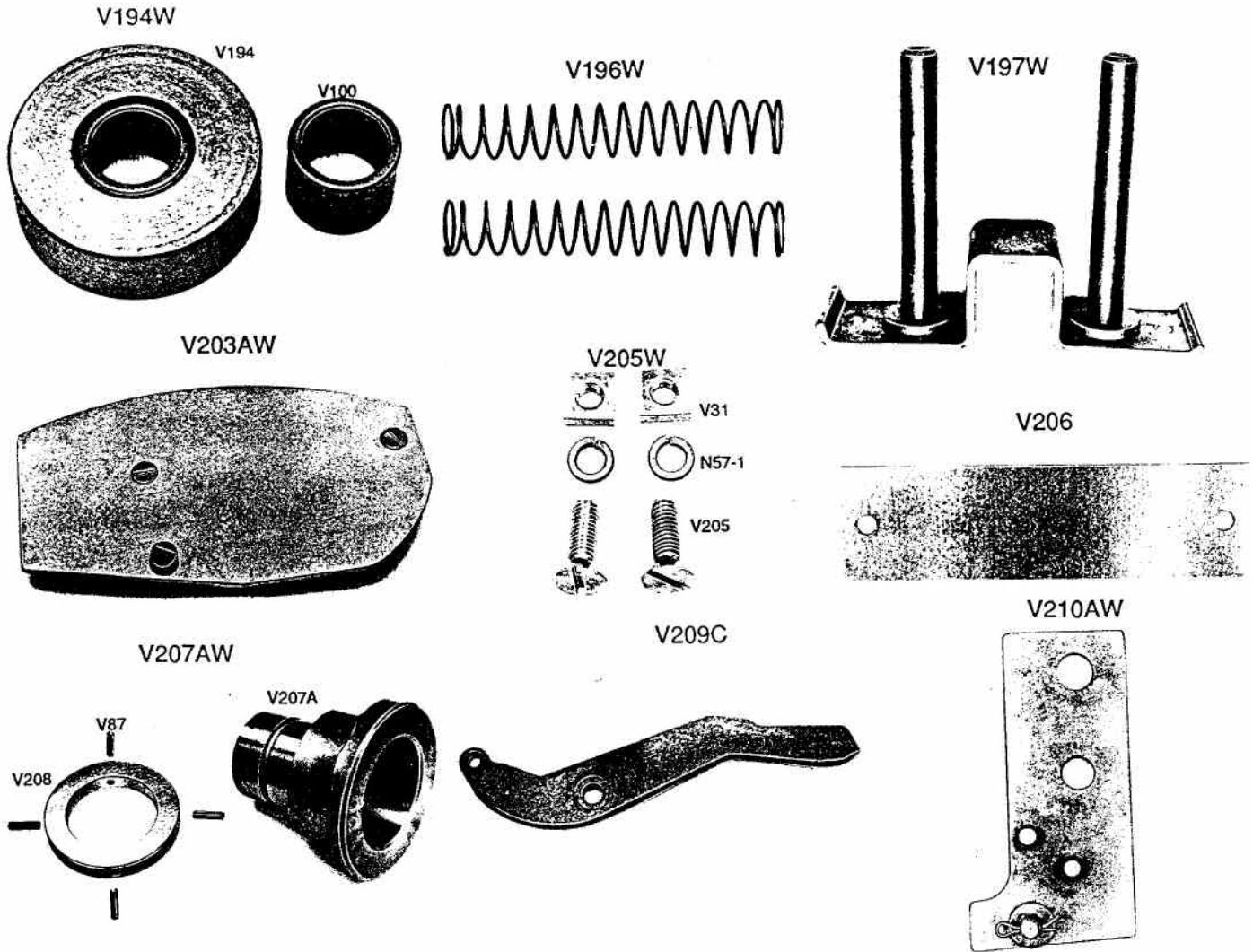

CAT.NO.	NAME
V194W	Feed Shelf Operating Roll Assembly
V196W	Feed Shelf Lifting Springs (set of 2)
V197W	Feed Shelf Operating Bracket Assembly
V203AW	Target Feed Shelf Assembly
V204A	Guide Button (not shown)
V205W	Target Feed Shelf Bolt (set of 2)
V206	Feed Shelf Shim (1/32" thick)
V207AW	Target Feed Cam Assembly
V209C	Target Feed Finger
V210AW	Feed Finger Bracket Assembly

# V1574A & B

## Western Self-Loading Electric Skeet Trap Parts

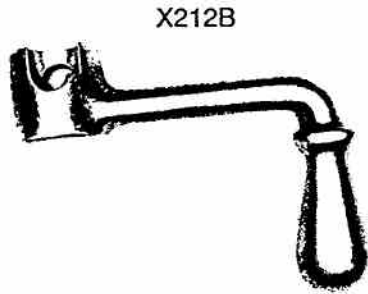

X212B



V214



V215A

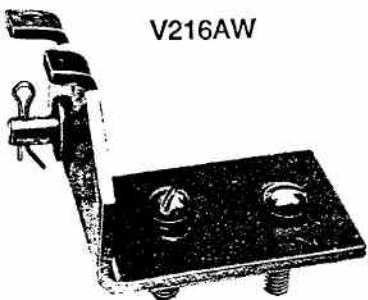

V216AW

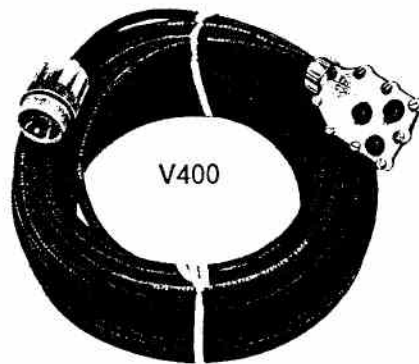

V400

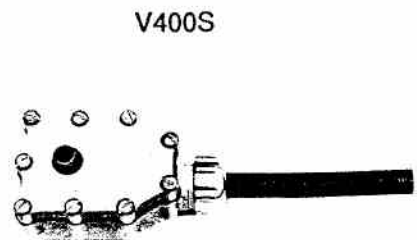

V400S

CAT.NO.	NAME
X212B	Mainspring Adjusting Speed Crank
V214	Spring for Target Feed & Stop Fingers
V215A	Target Stop Finger
V216AW	Stop Finger Bracket Assembly w/bolts
X190BW	Stop Finger Bracket Bolts Only (set of 2) (not shown)
X241	Oil Drain Plug (not shown)
U390	Hitch Pin for X39AW (not shown)
V400	Skeet Release Assembly
V400S	Skeet Release Switch End
V450	Safety Guard (not shown)



# V1577A, B, & V1582A, V1583A Assemblies

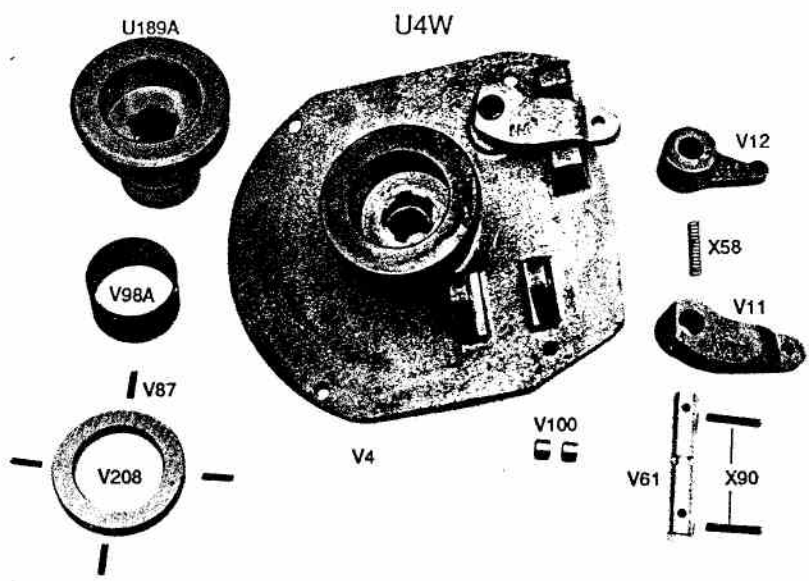
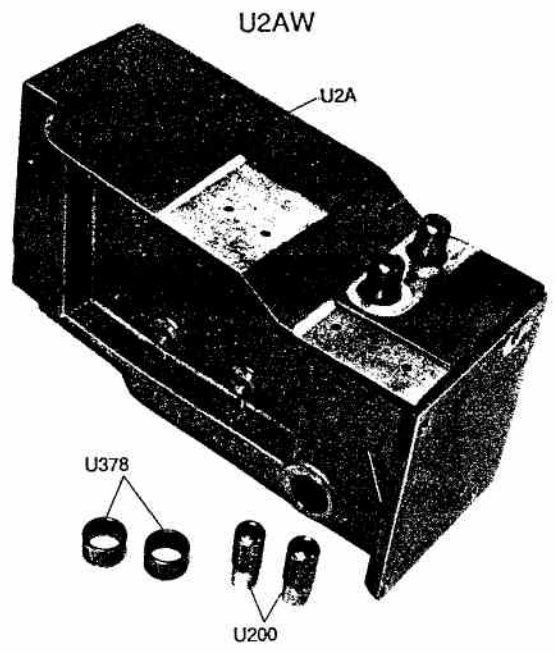
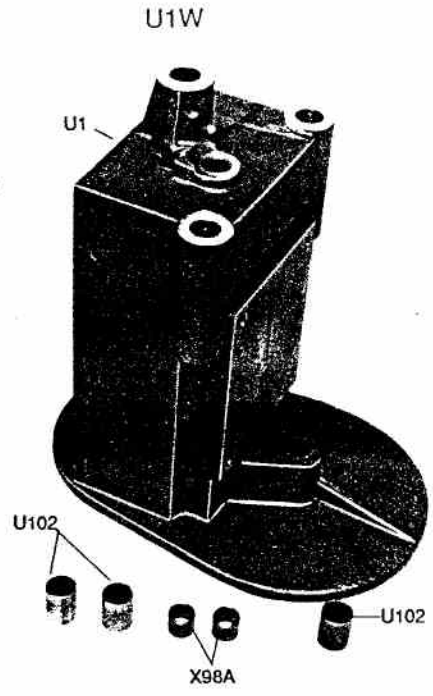

---

V1577A, B, & V1582A, V1583A  
Assemblies

**U1W**

U1 Magazine Support Bracket  
U102 Bushing  
X98A Hub Bearing

**U2AW**

U2A Frame  
U200 Bushing  
U378 Bushing

**U4W**

U189A Target Feed Cam  
V98A Bushing  
V87 Roll Pin  
V208 Feed Cam Collar  
V4 Gear Box Cover  
V100 Bushing  
V12 Trigger Dog  
V11 Trigger Arm  
X58 Trigger Spring  
X90 Roll Pin  
V61 Trigger Shaft

# V1577A, B, & V1582A, V1583A Assemblies

U27AW

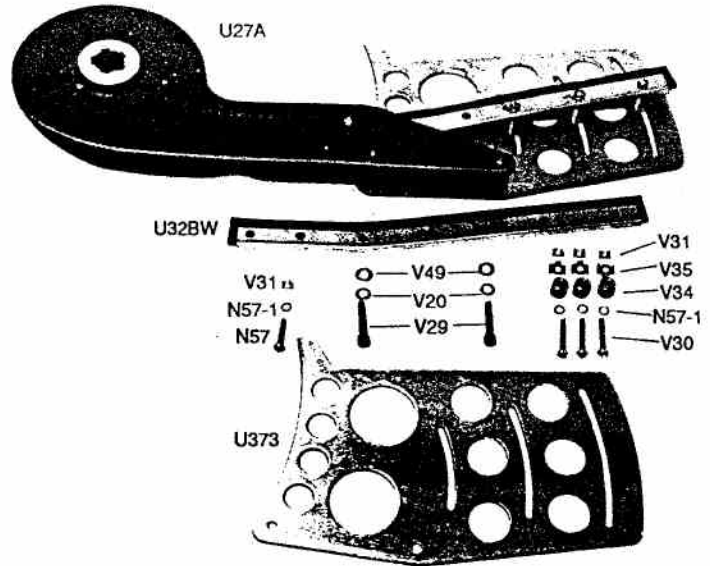

U29W

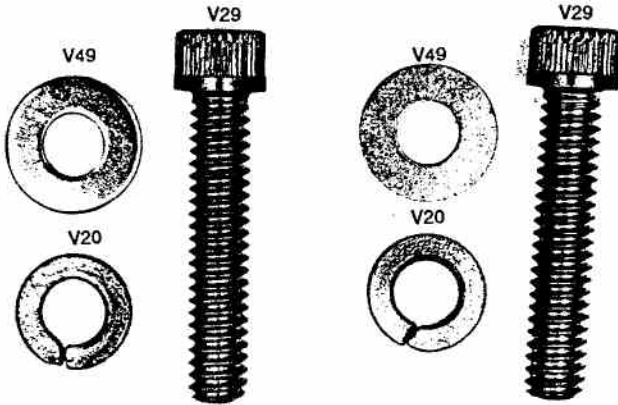

XU44W

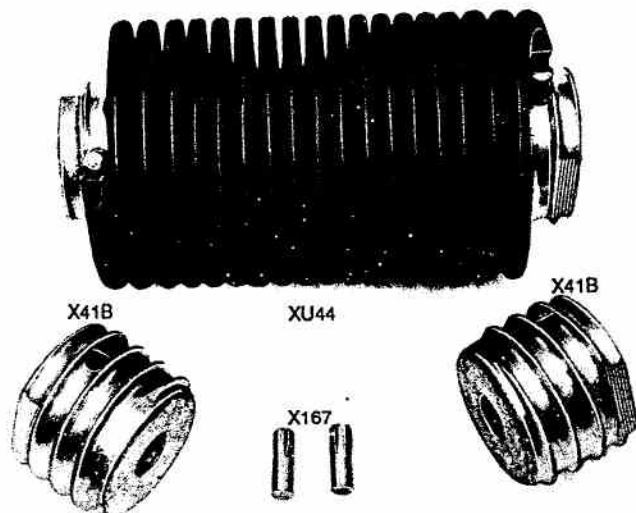

# V1577A, B, & V1582A, V1583A Assemblies

U85W

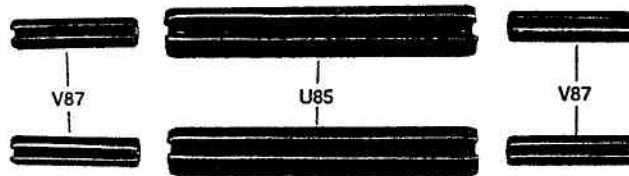

## U27AW

N57	Carrier Rail Screw
N57-1	Washer
U27A	Carrier Arm (Intl)
U32BW	Carrier Rail Assembly (Intl)
U373	Carrier Plate (Intl)
V20	Lockwasher
V29	Screw
V30	Screw
V31	Nut
V34	Rail Support
V35	Anchor Carrier Rail Nut
V49	Washer

## U29W

V20	Lockwasher
V29	Screw
V49	Washer

## XU44W

X41B	Mainspring Plug
XU44	Mainspring Coil
X167	Pins

## U85W

U85	Roll Pin
V87	Roll Pin

# V1577A, B, & V1582A, V1583A Assemblies

U142W

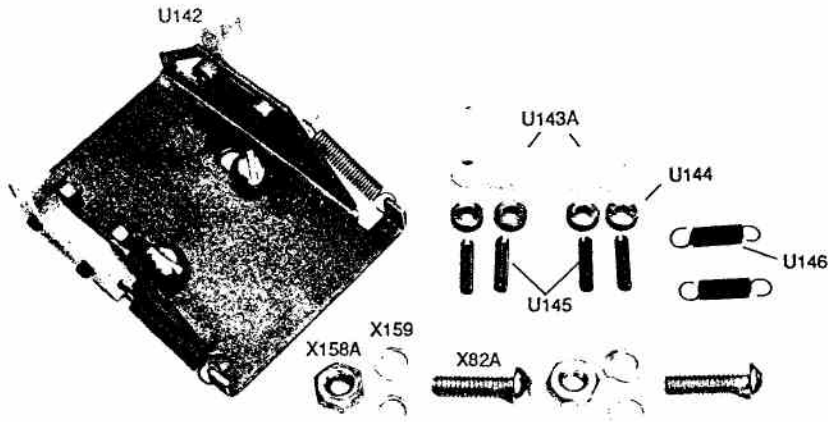

U150AW

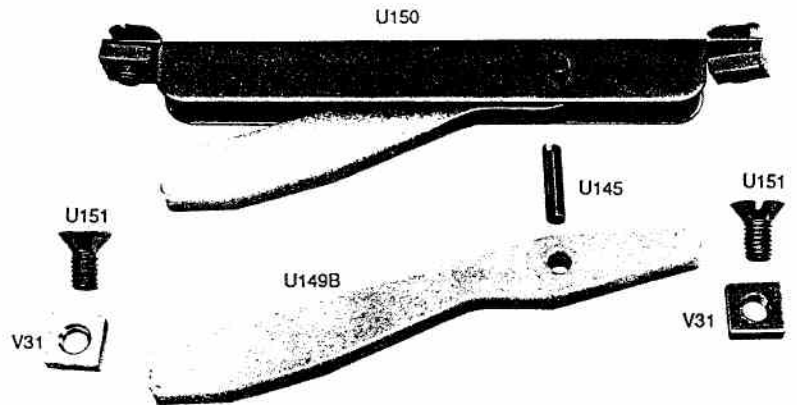

U156W

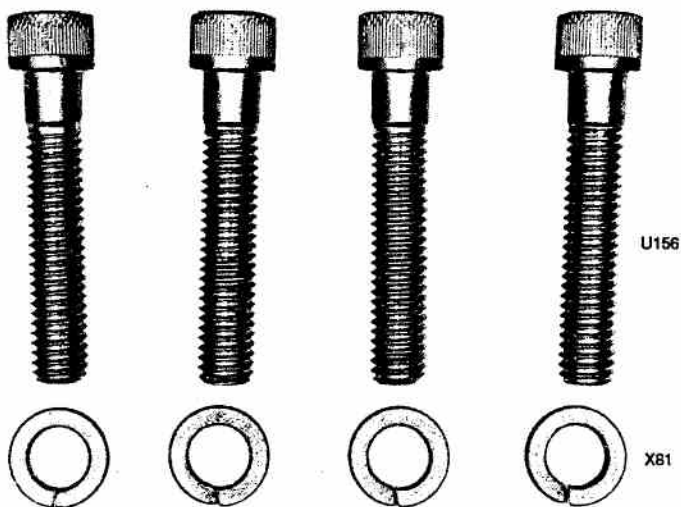

# V1577A, B, & V1582A, V1583A Assemblies

U174BW

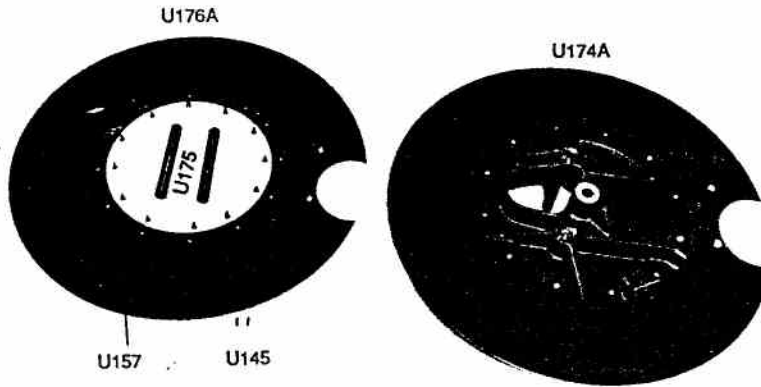

## U142W

U142	Target Stop Bracket
U143A	Target Stop Finger
U144	Collars
U145W	Roll Pins
U146	Spring
X82A	Screw (Set of 4)
X158A	Nut
X159	Lockwashers

## U150AW

U145	Roll Pins
U149B	Target Guide Finger
U150	Finger Bracket
U151	Screw
V31	Nut

## U156W

U156	Cap Screw
X81	Washer

## U174BW

U145	Stop Finger Guide Pin (Set of 4)
U157	Target Loading Disc Rivet
U174A	Magazine Base
U176A	Target Loading Disc

# V1577A, B, & V1582A, V1583A Assemblies

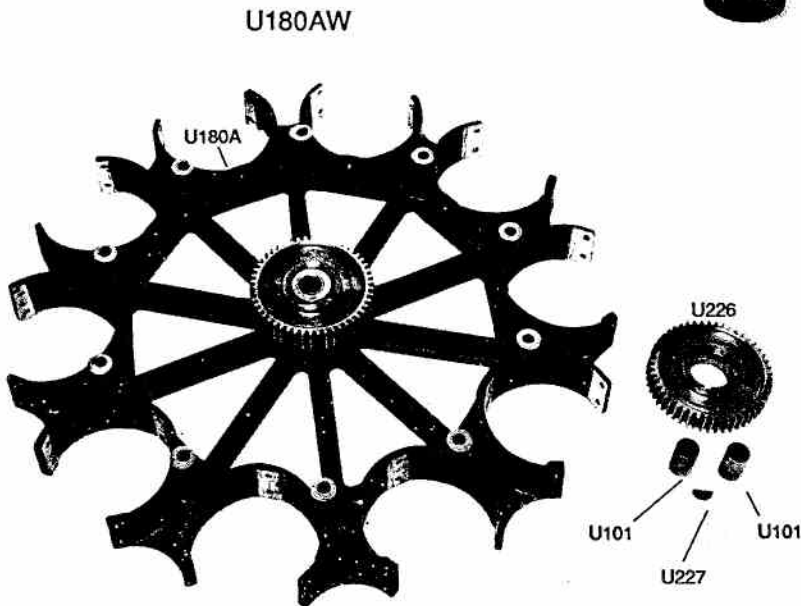
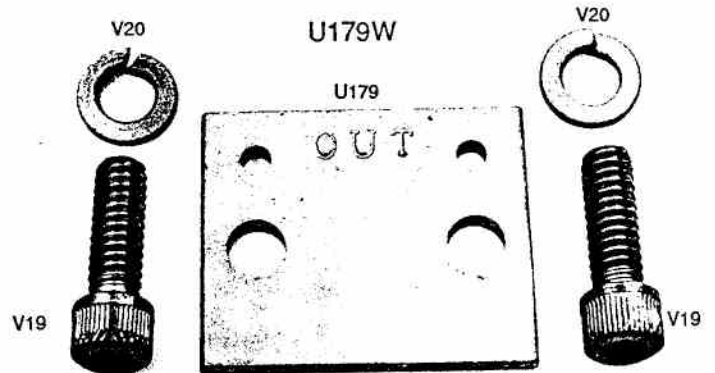
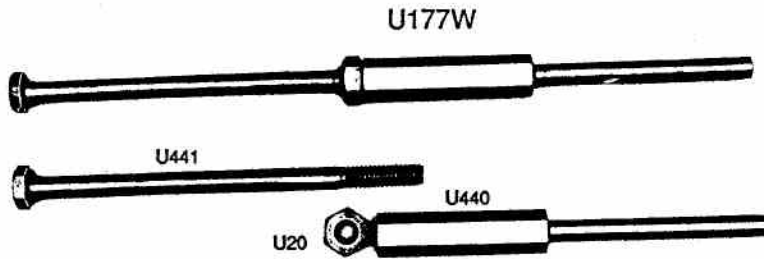

# V1577A, B, & V1582A, V1583A Assemblies

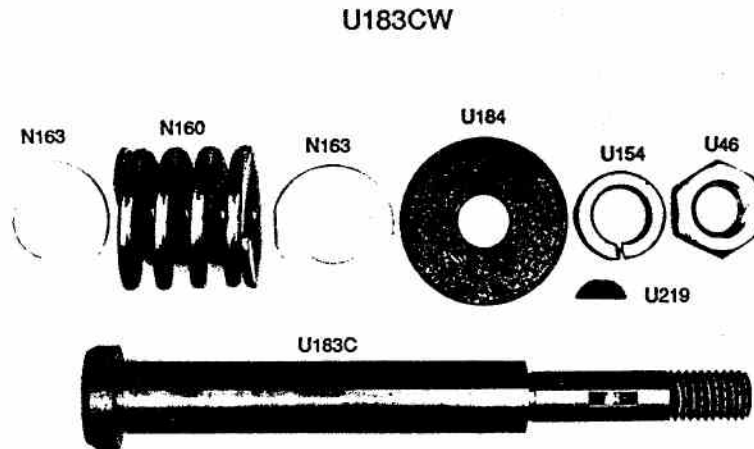

## U177W

U20      Hex Nut (Set of 12)  
U440      Escapement Plunger  
U441      Screw

## U179W

V19      Cap Screw (Set of 6)  
V20      Lockwasher  
U179      Escapement Push Rod

## U180AW

U101      Bushing  
U180A      Magazine Spider  
U226      Indexing Gear  
U227      Woodruff Key

## U183CW

N160      Spring  
N163      Upper Friction Spring  
U46      Hex Nut  
U154      Lockwasher  
U183C      Mounting Stud  
U184      Thrust Washer  
U219      Woodruff Key

# V1577A, B, & V1582A, V1583A Assemblies

U185W

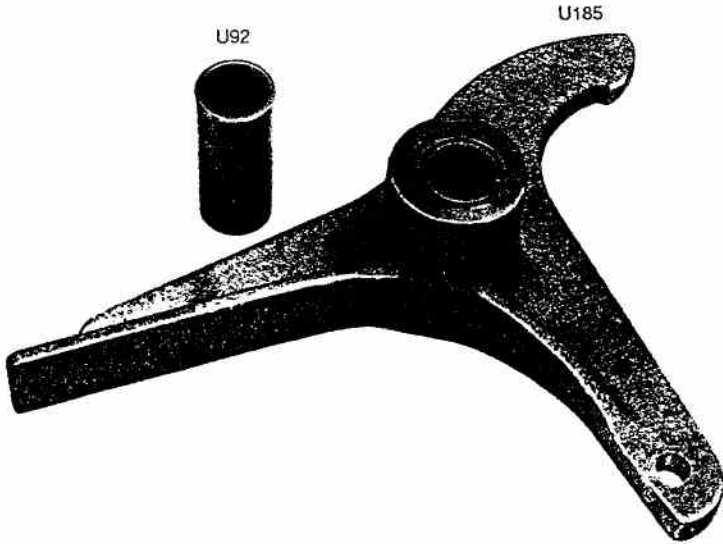

U189AW

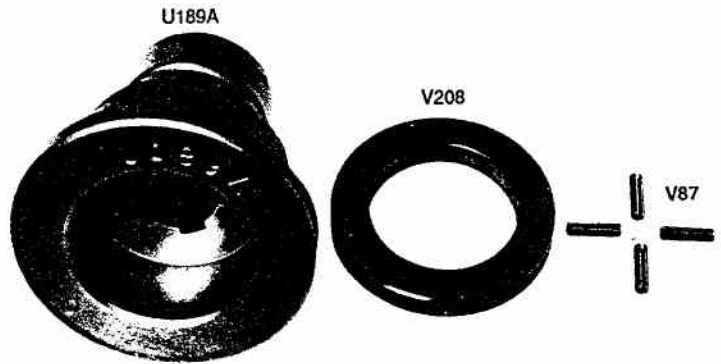

U187W

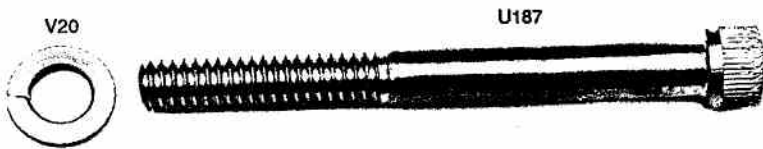

U204AW

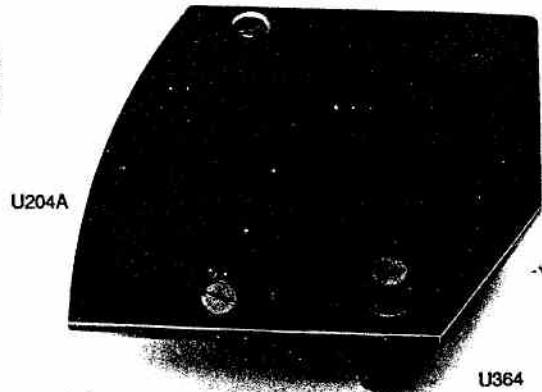

U204A

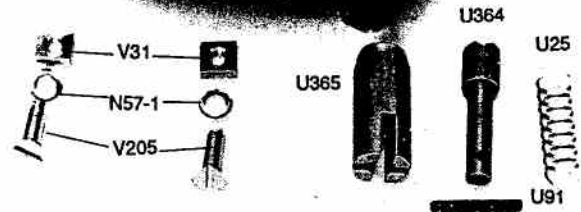

# V1577A, B, & V1582A, V1583A Assemblies

U190W

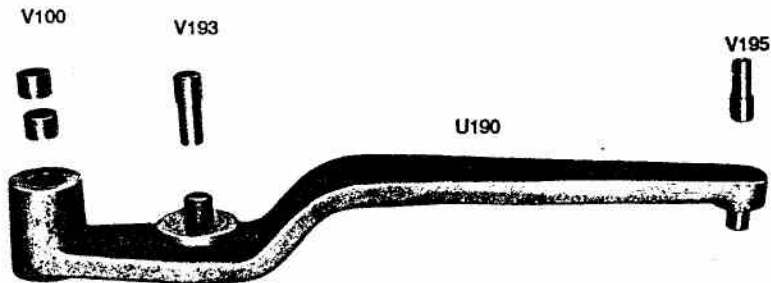

## U185W

U92 Bushing  
U185 Escapement Lever

## U187W

U187 Cap Screw  
V20 Lockwasher

## U189AW

V87 Roll Pin  
U189A Target Feed Cam  
V208 Feed Cam Collar

## U190W

U190 Target Feed Arm  
V100 Bushing  
V193 Stud  
V195 Stud

## U204AW

U25 Spring  
U91 Roll Pin  
U204A Target Feed Shelf  
U364 Target Stop Plunger  
U365 Stop Plunger Holder  
V31 Nut  
V205 Screw (set of 2)  
N57-1 Washer

# V1577A, B, & V1582A, V1583A Assemblies

U207W



U208W

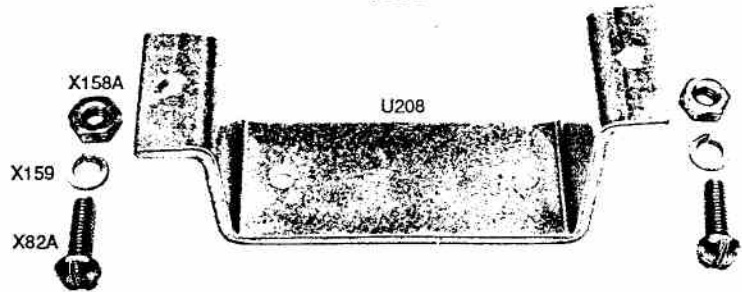

U210W

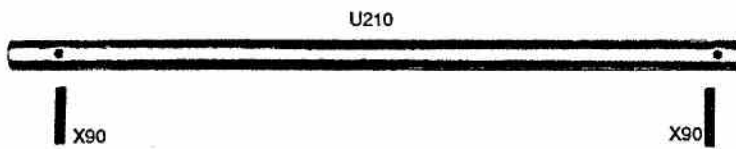

U211W



U214AW

U214A

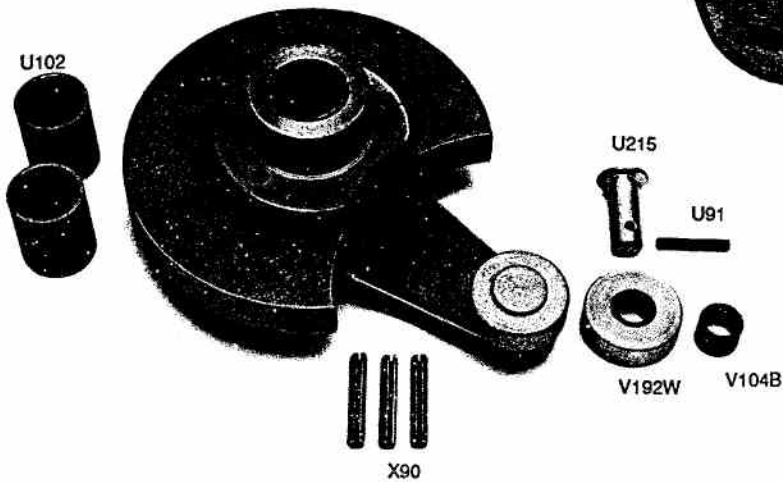

---

## V1577A, B, & V1582A, V1583A Assemblies

### U207W

U207	Guide Shelf
V31	Nut
V205	Screw (set of 2)
N57-1	Washer

### U208W

U208	Guide Shelf Bracket
X82A	Machine Screw
X158A	Nut
X159	Lockwasher

### U210W

U210	Push Rod Operating Shaft
X90	Roll Pin

### U211W

U48	Stud
U211	Escapement Roller Arm

### U214AW

U91	Roll Pin
U102	Bushing
U214A	Index Drive Gear
U215	Stud
V104B	Bushing
V192W	Feed Cam Roll Assembly
X90	Roll Pin

# V1577A, B, & V1582A, V1583A Assemblies

U216W

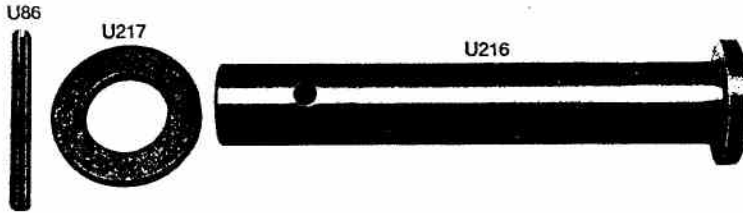

U224AW

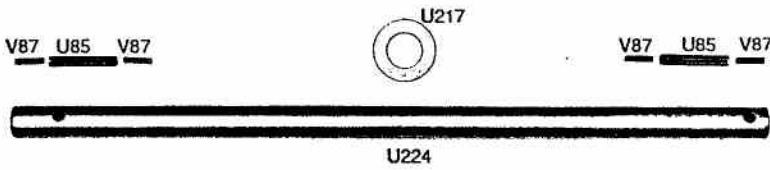

U220W

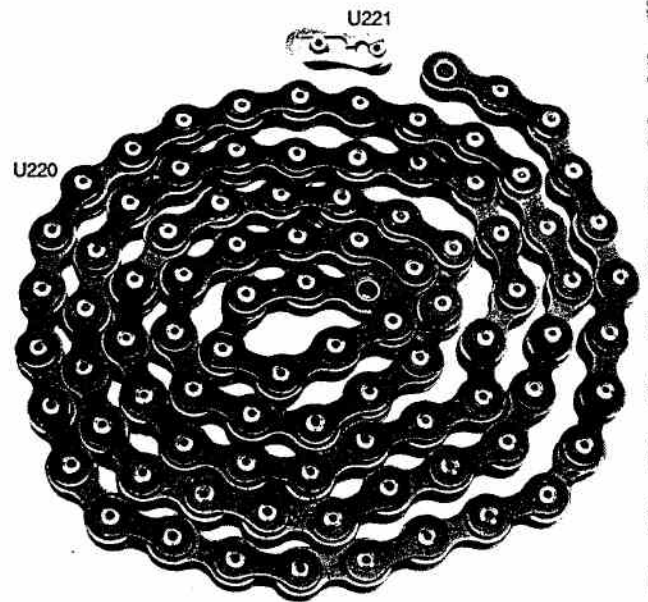

U301

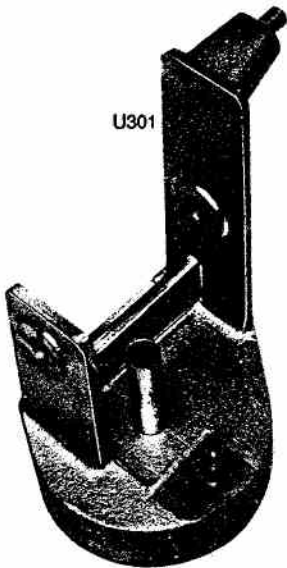

U301W

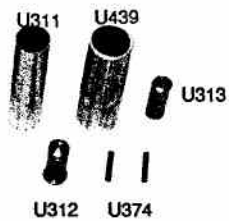

U302W

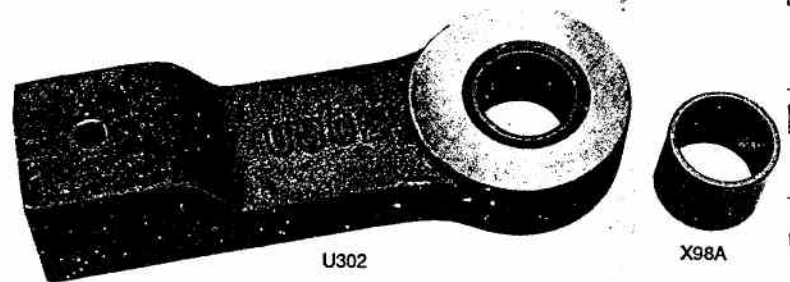

---

## V1577A, B, & V1582A, V1583A Assemblies

### U216W

U86	Roll Pin
U216	Index Drive Shaft
U217	Thrust Bearing

### U220W

U220	Index Chain
U221	Index Chain Connecting Link

### U224AW

U85	Roll Pin
U217	Thrust Bearing
U224	Index Gear
V87	Roll Pin

### U301W

U301	Base Swivel
U311	Cable Guide
U312	Horizontal Pivot
U313	Vertical Drive Pin
U374	Roll Pin
U439	Bearing Spacer

### U302W

U302	Rod End
X98A	Bushing